



● Thank you for purchasing our product. This product is a multifunction meter and is easy to install. Before using, please read the instructions carefully and retain them for future reference.

Attention!

- For installation, please follow the steps described. Any damage caused by wrong installation shall be imputed to the users.
- To avoid a short circuit from occurring do not pull or modify the wires during installation.
- Do not disassemble or change any parts. Opening and disassembling this unit will void any warranty.
- Maintenance and repairs should be executed by our professionals only.

◎ Symbol description:

NOTE

△ Some procedures must be followed to avoid damages to the instrument.

△ **WARNING!** Certain procedure must be followed to avoid damages to yourself, to the vehicle or others.

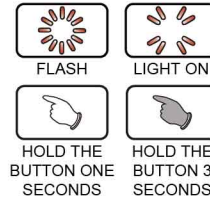

1 Accessories

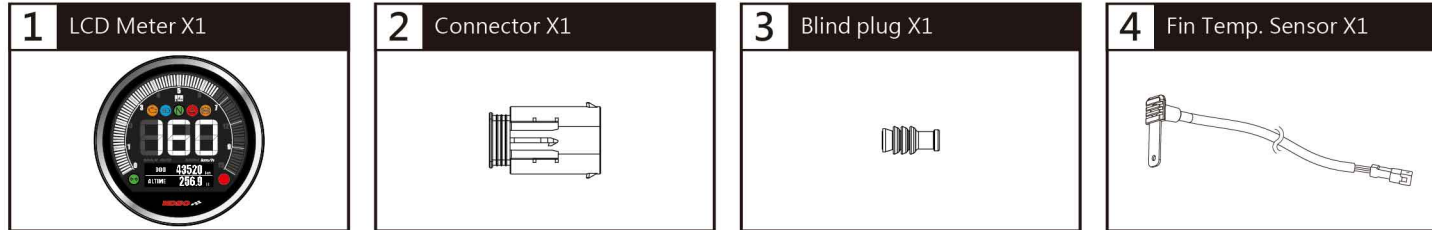

NOTE Contact your local distributor if the items received are not the same as the items listed above.

2-1 Installation instructions

When installing, please follow the steps below.

1. M5X12L mm Screw x1 (Original part)
2. Meter x1 (Accessory 1)

NOTE Upon installation, the meter shall be placed in after the main wiring has circled the meter holder for one round.

NOTE To disassemble, please refer to the instruction above, and install according to the reverse order of assembly.

2-2 Wiring installation instructions

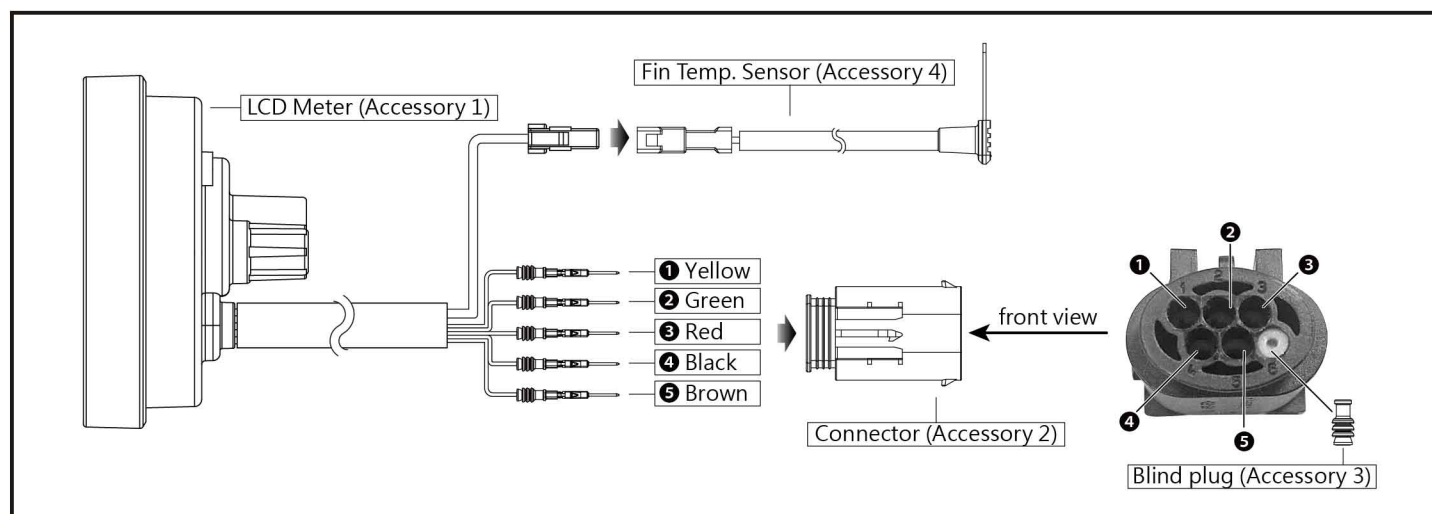

2-3 Fin Temp. Sensor installation instructions

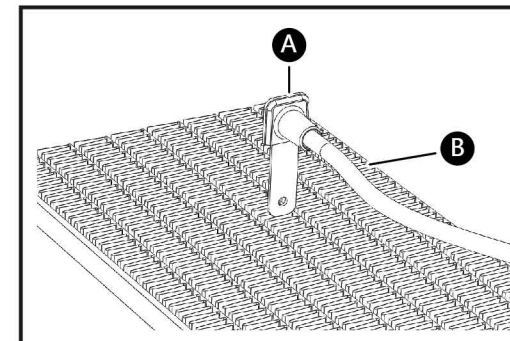

Follow the steps below during installation.

1. Please make sure that the (A) Fin Temp. Sensor (Accessory 4) is the correct size.
2. Please apply lubricant with temperature resistance on the sensor copper plate to ensure the temperature transfer effect, and please keep the surroundings of the blade clean.
3. Please insert (A) Fin Temp. Sensor (Accessory 4) into the (B) Water Tank carefully to avoid damaging the cooling blade.

NOTE The installation location shall be set at the surrounding of the water (oil) tube.

△ The lubricant shall only apply to the surface of the blade that will be inserted into the water. Over application may cause dust adhesion and affect the cooling.

△ Please do not install right in front of the cooling fan, or else it may affect the sensing temperature or cause damages to the blades of the fan.

△ Keep the wires away from high heat sources to avoid damages. (Such as exhaust pipe and air-cooled cylinder)

△ **WARNING!** Please do not stuff or insert the Fin Temp. Sensor into the Water Tank by force to avoid damaging the structure of the Water Tank.

3-1 Basic function instruction

- Tachometer**
 - Display range : 0 ~ 10,000 RPM / 0 ~ 15,000 RPM
- Speedometer**
 - Display range : 0 ~ 360 km/h (0 ~ 225 MPH)
- Indication light**
 - Engine warning light
 - High beam light
 - Neutral
 - Warning light
 - ABS
 - Trun signal
 - RPM shift light
- Clock**
 - Setting range : 12 / 24 hour system
 - Voltage
 - Display range : 8.0 ~ 18.0 V
- Highest record**
 - Highest speed per hour
 - Highest rotation speed
 - Highest temperature
 - Highest voltage
 - Highest gear
- Internal and external odometer**
 - Display range : 0 ~ 99,999 km (mile)
 - Display unit : 1 km (mile)
 - Trip meter 1 - 2
 - Display range : 0 ~ 9,999.9 km (mile)
 - Display unit : 0.1 km (mile)
 - Trip meter O - Motor oil maintenance
 - Display range : 0 ~ 9,999.9 km (mile)
 - Display unit : 0.1 km (mile)
 - Trip meter A - Mileage for the remaining oil level
 - Display range : 0 ~ 9,999.9 km (mile)
 - Display unit : 0.1 km (mile)
- Gear**
 - Display range : N - 1 ~ 6
- Total engine hour meter**
 - Display range : 0.0 ~ 9999.9 HOUR
 - Display unit : 0.1 HOUR (6 minutes)
 - Hour meter 1 - 2
 - Display range : 0.0 ~ 9999.9 HOUR
 - Display unit : 0.1 HOUR (6 minutes)
 - Low oil level operating time A
 - Display range : 0.0 ~ 9999.9 HOUR
 - Display unit : 0.1 HOUR (6 minutes)
- Temperature**
 - Display range : 0 ~ 250°C (32 ~ 482°F)

3-2 Specifications

● Speedometer	Display range : 0 ~ 360 km/h (0 ~ 225 MPH) Display unit : 1 km/h	● Total engine hour meter	Display range : 0.0 ~ 9999.9 HOUR Display unit : 0.1 HOUR (6 minutes)
○ Internal and external odometer	Display range : 0 ~ 99,999 km (mile) Display unit : 1 km (mile)	○ Hour meter 1 - 2	Display range : 0.0 ~ 9999.9 HOUR Display unit : 0.1 HOUR (6 minutes)
● Trip meter 1 - 2	Display range : 0 ~ 9,999.9 km (mile) Display unit : 0.1 km (mile)	○ Low oil level operating time A	Display range : .0 ~ 9999.9 HOUR Display unit : 0.1 HOUR (6 minutes)
● Trip meter O	Motor oil maintenance Display range : 0 ~ 9,999.9 km (mile) Display unit : 0.1 km (mile)	● Highest record	Highest speed per hour Display range : 0 ~ 360 km/h (0 ~ 225 MPH) Highest rotation speed Display range : 0 ~ 15,000 RPM Highest temperature Display range : 0 ~ 250°C (32 ~ 482°F) Highest voltage Display range : 8.0 ~ 18 V Highest gear Display range : N - 1 ~ 6
○ Trip meter A	Mileage for the remaining oil level Display range : 0 ~ 9,999.9 km (mile) Display unit : 0.1 km (mile)	● Clock	Setting range : 12 / 24 hour system
● Oil maintenance mileage	Setting range : 3,000 ~ 16,000 km (300 ~ 10,000 mile) Setting unit : 100 km (mile)	● Back light brightness	Setting range : 1 - 5 (Darkest) ~ 5 - 5 (Brightest)
● Gear	Display range : N - 1 ~ 6	○ Voltage	DC 12V
● Speeding warning setting	Setting range : 30 ~ 360 km/h (18 ~ 225 MPH) Setting unit : 1 km/h (MPH)	● Operating temperature	-10 ~ +60°C
● Tachometer	Display range : 0 ~ 10,000 RPM / 0 ~ 15,000 RPM	○ Specification	JIS D 0203(S2)
● Shift light warning	Setting range : 5,000 ~ 15,900 RPM Setting unit : 100 RPM	● Meter Size	D 96 mm
● Temperature	Display range : 0 ~ 250°C (32 ~ 482°F)	○ Meter Weight	Around 194.5 g
● Overheat warning	Setting range : 60 ~ 250°C (140 ~ 482°F) Setting unit : 1°C (°F)	● Indication light	● Engine warning light ● High beam light ● Neutral ● Warning light
● Voltage	Display range : 8.0 ~ 18.0 V		● ABS ● Trun signal ● RPM shift light
● Low voltage warning	Setting range : 8.0 ~ 12.5 V		

NOTE Design and specification may change without further notice.

3-3 Meter size

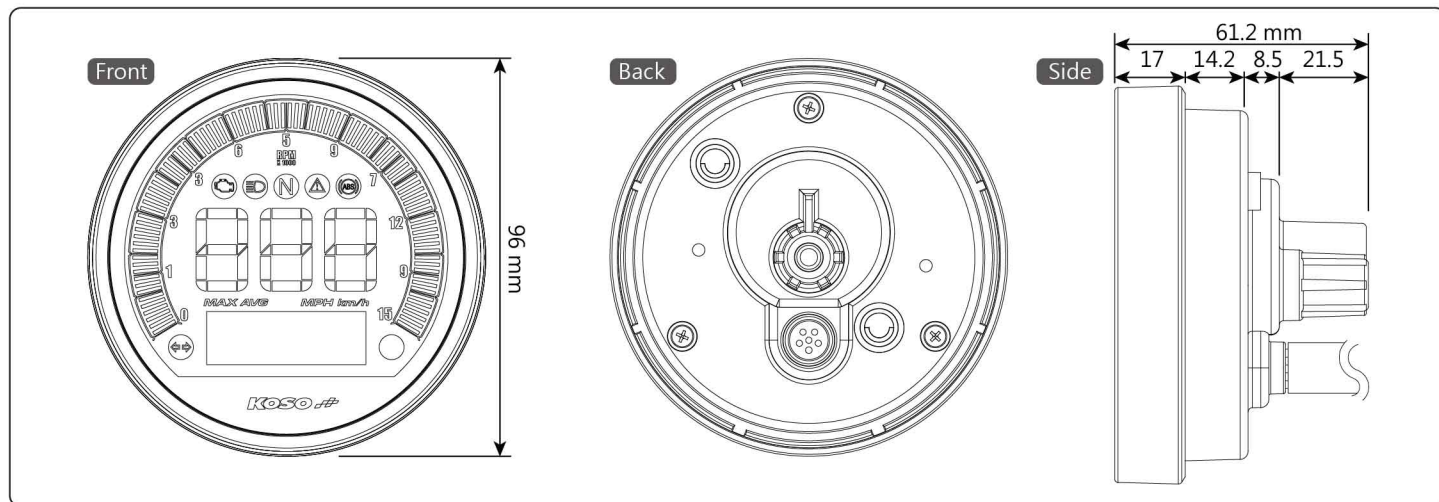

3-4 Fin Temp. Sensor Size

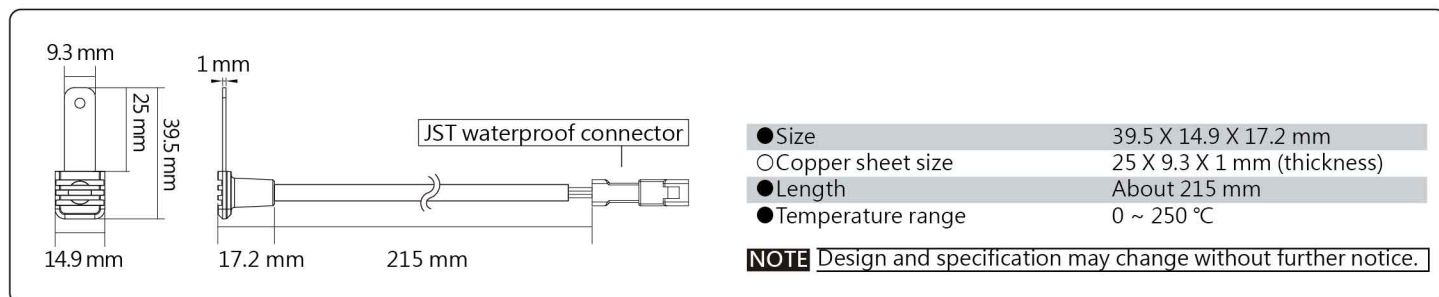

3-5 INFO button function shifting instructions

● Total Odometer screen, press INFO button once to switch to **Trip 1** screen.

● Hold the INFO button for 3 seconds enter the setting screen.

● Trip 1 screen, press INFO button once to switch to **Trip 2** screen.

● Hold the INFO button for 3 seconds, clear the records for 2 functions at the same time.

● Trip 2 screen, press INFO button once to switch to **Trip meter O - Motor oil maintenance** screen.

● Hold the INFO button for 3 seconds, clear the records for 2 functions at the same time.

● Trip meter O - Motor oil maintenance screen, press INFO button once to switch to highest record screen.

● Hold the INFO button for 3 seconds, clear the distance table O - oil mileage records.

● Highest voltage screen, press INFO button once to switch to **Total Odometer** screen.

● Highest temperature screen, press INFO button once to switch to **Total engine hour meter** screen.

● Hold the INFO button for 3 seconds, clear the records for 5 functions at the same time.

NOTE 5 functions: ① Highest speed per hour ② Highest rotation speed ③ Highest temperature ④ Highest voltage ⑤ Highest gear

● Total Odometer screen.

3-6 Button, heating grip, and function shifting instructions

● Clock screen, press button of the heating grip once to shift to the heating grip - OFF screen.

● Heating grip - OFF screen, press the button of the heating grip once to shift to the heating grip - gear 1 screen.

● Heating grip - 1 screen, press the button of the heating grip once to shift to the heating grip - gear 2 screen.

● Heating grip - 2 screen, press the button of the heating grip once to go back to the Clock screen.

4 The settings screen description

● Main screen → **● Enter the setting screen**

1 Clock **2** Unit (Speed/Temperature) **3** Backlight **4** Tire circumference **5** Speeding warning **6** RPM **7** Shift light warning **8** Overheat warning **9** Low voltage warning **10** Motor oil maintenance **11** Internal and External ODO **12** Exit

● Hold the INFO button for 3 seconds, on the main screen to shift to the setting screen.

● Press INFO button once and select ① Clock ② Unit (Speed / Temperature) ③ Backlight ④ Tire circumference ⑤ Speeding warning ⑥ RPM ⑦ Shift light warning ⑧ Overheat warning ⑨ Low voltage warning ⑩ Motor oil maintenance ⑪ Internal and External ODO ⑫ Exit

● Hold the INFO button for 3 seconds, to enter the function setting screen.

NOTE Enter the setting screen, the system would automatically return to the starting screen where no button is pressed for over 30 seconds.

4-1 Clock Setting

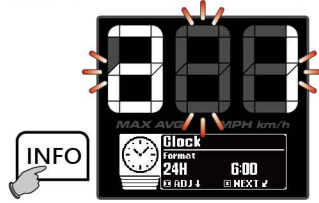

- The Clock screen, press the INFO button for 3 seconds to enter the clock setting.

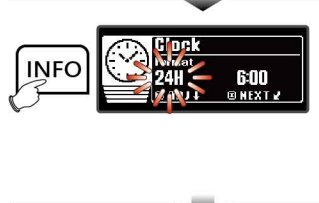

- Example : Changing the 12H.
- Press the INFO button to choose the setting number.
- Now the setting value is flashing!
- NOTE Setting range : 12 H, 24 H. Default value : 24 H.

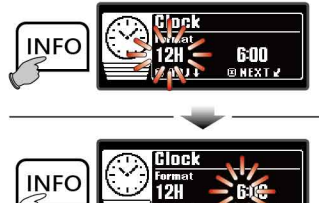

- EX : Set time format from 24 H to 12 H.
- Press the INFO button for 3 seconds to enter time (hour) setting.



- Example : To set clock (hour) as 10 hours.
- Press the INFO button to choose the setting number.
- Now the setting value is flashing!
- NOTE Cursor moving order is : Hour → Digit in ten minutes → Digit in minutes
- NOTE Setting range : 1 ~ 12 (12 H) 0 ~ 23 (24 H) Default value : 12(12H) / 0(24H)

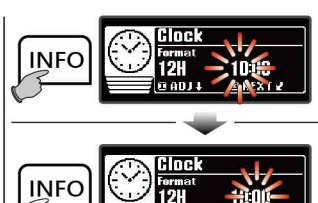

- EX : Set hour from 6:00 AM to 10:00 PM.
- Press the INFO button for 3 seconds to enter clock (ten minute) setting.



- Example : To set clock(ten minute) as 10 minutes.
- Press the INFO button to choose the setting number.
- Now the setting value is flashing!

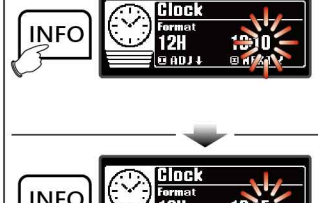

- EX : Set ten minute from 0 to 10.
- Press the INFO button for 3 seconds to enter clock (minute) setting.



- Example : To set clock (minute) as 5 minute.
- Press the INFO button to choose the setting number.
- Now the setting value is flashing!



- EX : Set minute from 0 minute to 5 minutes.
- Press the INFO button for 3 seconds to go back to the clock screen.
- Clock main screen.
- Press INFO button once to enter next setting.

4-2 Unit (Speed, Temperature) Setting



- The Unit screen, press the INFO button for 3 seconds to enter the speed unit setting.



- Example : To set speed unit as MPH.
- Press the INFO button to choose the setting number.
- Now the setting value is flashing!
- NOTE Setting range : km/h, MPH. Default value : km/h.



- EX : Set speed unit from km/h to MPH.
- Press the INFO button for 3 seconds to enter the temp. unit setting screen.
- Now the setting value is flashing!
- NOTE Setting range : km/h, MPH. Default value : km/h.

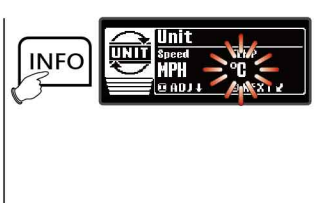

- Example : To set temp. unit to °F.
- Press the INFO button to choose the setting number.
- Now the setting value is flashing!
- NOTE Setting range : °C (Celsius) and °F (Fahrenheit). Default value : °C (Celsius).



- EX : Set temp. unit from °C (Celsius) to °F (Fahrenheit).
- Press the INFO button for 3 seconds to go back to the unit (speed, temp.) screen.

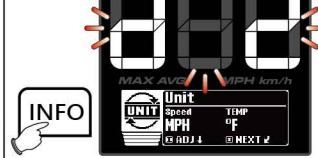

- The unit (speed, temp.) screen.
- Press INFO button once to enter next setting.

4-3 Backlight Setting

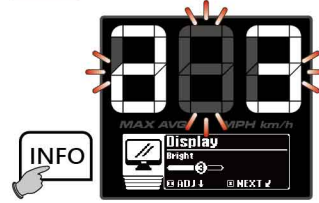

- The backlight screen, press the INFO button for 3 seconds to enter the backlight setting.



- Example : To set the backlight at 5(100%).
- Press the INFO button to choose the setting number.
- Now the setting value is flashing!
- NOTE Setting range : 1 ~ 5 (Brightest). Setting unit : 20% per level. Default value : 3(60%).



- NOTE The backlight brightness will change immediately after you set the value.
- EX : Set backlight from 3(60%) minute to 5(100%).
- Press the INFO button for 3 seconds to go back to the backlight screen.



- The backlight screen.
- Press INFO button once to enter next setting.

4-4 Tire Circumference Setting



- The tire circumference screen, press the INFO button for 3 seconds to enter the tire circumference setting.
- Please reset this setting value if you change to a different tire size.



- Press the INFO button to choose the setting number.
- Now the setting value is flashing!
- NOTE Setting range : 50 ~ 200 %. Default value : 100%.

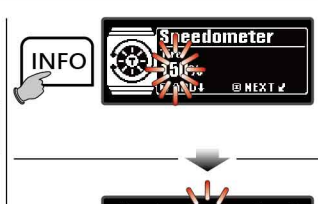

- EX : Set the tire circumference from 100 % to 150 %.
- Press the INFO button for 3 seconds to go back to the tire circumference screen.

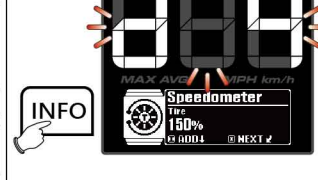

- The tire circumference screen.
- Press INFO button once to enter next setting.

4-5 Speeding Warning Setting



- The speeding warning screen, press the INFO button for 3 seconds to enter the speeding warning setting.



- Example : To set speeding warning value to 80 km/h.
- Press the INFO button for 3 seconds to move to the digit you want to set.
- Now the setting value is flashing!
- NOTE Setting range : 30 ~ 360 km/h (18 ~ 225 MPH) Default value : 90 km/h (56MPH)



- Press the INFO button to choose the setting number.



- EX : Set the speed warning from 50 km/h to 80 km/h.
- Press the INFO button for 3 seconds to go back to the speed warning screen.



- The speed warning screen.
- Press INFO button once to enter next setting.

4-6 RPM Setting



- The RPM screen, press the INFO button for 3 seconds to enter the RPM setting.

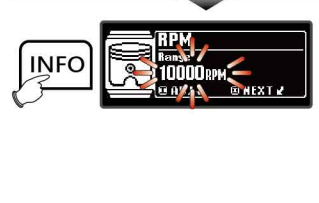

- Example : To set the RPM at 15,000 RPM.
- Press the INFO button to choose the setting number.
- Now the setting value is flashing!
- NOTE Setting range : 10,000 ~ 15,000 RPM. Default value : 10,000 RPM.

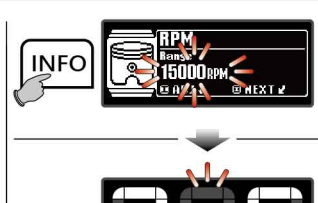

- EX : Set the RPM from 10,000 RPM to 15,000 RPM.
- Press the INFO button for 3 seconds to go back to the RPM screen.



- RPM screen.
- Press INFO button once to enter next setting.

4-7 Shift Light Warning Setting

● The shift light warning screen, press the INFO button for 3 seconds to enter the shift light warning setting.

● Press the INFO button to choose the setting number.

● EX : Set the shift light warning from 6,000 RPM to 9,000 RPM.

● Press the INFO button for 3 seconds to go back to the shift light screen.

● Shift light warning screen.

● Press INFO button once to enter next setting.

● Example : To set Shift Light Warning value to 9,000 RPM.

● Press the INFO button for 3 seconds to move to the digit you want to set.

⚠ Now the setting value is flashing!

NOTE Setting range :
5,000 ~ 15,900 RPM *
Default value : 6,000 RPM *

4-8 Overheat Warning Setting

● The overheat warning screen, press the INFO button for 3 seconds to enter the overheat warning setting.

● Press the INFO button to choose the setting number.

● EX : Set the overheat warning from 90 °C to 120 °C.

● Press the INFO button for 3 seconds to go back to the overheat warning screen.

● Overheat warning screen.

● Press INFO button once to enter next setting.

● Example : To set the overheat warning at 120 °C.

● Press the INFO button to choose the setting number.

⚠ Now the setting value is flashing!

NOTE Setting range :
60 ~ 250 °C (140 ~ 482 °F).
Default value : 90 °C (194 °F).

● Press the INFO button for 3 seconds to choose the setting number.

4-9 Low Voltage Warning Setting

● The low voltage warning screen, press the INFO button for 3 seconds to enter the low voltage warning setting.

● Press the INFO button to choose the setting number.

● EX : Set the low voltage warning from DC 11.5 V to DC 11.0 V.

● Press the INFO button for 3 seconds to go back to the low voltage warning screen.

● Low voltage warning screen.

● Press INFO button once to enter next setting.

● Example : To set low voltage warning value to DC 11.0 V.

● Press the INFO button for 3 seconds to move to the digit you want to set.

⚠ Now the setting value is flashing!

NOTE Setting range :
DC 8.0 ~ 12.5 V.
Default value : 11.5 V.

4-10 Motor Oil Maintenance Setting

● The motor oil maintenance screen, press the INFO button for 3 seconds to enter the motor oil maintenance setting.

● Press the INFO button to choose the setting number.

● EX : Set the motor oil maintenance from 3,000 km to 12,000 km.

● Press the INFO button for 3 seconds to go back to the motor oil maintenance screen.

● Motor oil maintenance screen.

● Press INFO button once to enter next setting.

● Example : To set motor oil maintenance at 12,000 km.

● Press the INFO button to choose the setting number.

⚠ Now the setting value is flashing!

NOTE Setting range :
3,000 ~ 160,000 km
(300 ~ 10,000 mile).
Default value :
3,000 km (1,700 mile) *

● Press the INFO button for 3 seconds to move to the digit you want to set.

4-11 Internal and External ODO Setting

● The internal and external ODO screen, press the INFO button for 3 seconds to enter the external ODO setting.

⚠ User unable to adjust or clear internal ODO.

NOTE Display range :
0 ~ 99,999 km (mile).

● Press the INFO button for 3 seconds to move to the digit you want to set.

● Press the INFO button to choose the setting number.

● EX : Set external total distance value from 30,000 km to 12,000 km.

● Press the INFO button for 3 seconds to go back to the internal and external ODO screen.

● Internal and external ODO screen.

● Press INFO button once to enter next setting.

● Example : To set external total distance value to 12,000 km.

● Press the INFO button to choose the setting number.

⚠ Now the setting value is flashing!

NOTE Cursor's order :
one hundred → thousand →
thousands → thousand →
hundred → ten → digit.

NOTE Display range :
0 ~ 99,999 km (mile).

4-12 Exit Setting

● Exit screen, press the INFO button for 3 seconds to go back to the main screen.

● Main screen.

5 Trouble Shooting

The following situations do not indicate malfunction of the meter. Please check the following before taking it in for repairs.

Trouble	Check item	Trouble	Check item
The meter doesn't work when the power is on.	<ul style="list-style-type: none"> ● The power isn't supplied to the meter. → Please make sure the wiring is connected. The wiring and fuse are not broken. → The battery is too old to supply needed power (DC 12 V). 	Thermometer doesn't appear or appear incorrectly.	<ul style="list-style-type: none"> ● Make sure the temperature wire is connected properly. → Please check the temperature wire is connected correctly. ● May be wrong setting. → Please check the setting list to see whether the setting for temperature and others are correct.
The meter shows wrong information.	<ul style="list-style-type: none"> ● Check the voltage of your battery, and make sure the voltage is over DC 12 V. 	Voltage doesn't appear or appear incorrectly.	<ul style="list-style-type: none"> ● Wirings for the connector may be poorly installed. → Please confirm whether the wirings for the connector are properly installed and whether the wirings are connected. ● May be wrong setting. → Please check the setting list to see whether the setting for clock and others are correct.
Speed meter doesn't appear or appears incorrectly.	<ul style="list-style-type: none"> ● Wirings for the connector may be poorly installed. → Please confirm whether the wirings for the connector are properly installed and whether the wirings are connected. ● May be wrong setting. → Please check the setting list to see whether the setting for speed and others are correct. 	The clock is incorrect.	<ul style="list-style-type: none"> ● Wirings for the connector may be poorly installed. → Please confirm whether the wirings for the connector are properly installed and whether the wirings are connected. ● May be wrong setting. → Please check the setting list to see whether the setting for clock and others are correct.
Tachometer doesn't appear or appears incorrectly.	<ul style="list-style-type: none"> ● Wirings for the connector may be poorly installed. → Please confirm whether the wirings for the connector are properly installed and whether the wirings are connected. ● May be wrong setting. → Please check the setting list to see whether the setting for rotation speed and others are correct. 	The pilot lamp shows nothing or shows error.	<ul style="list-style-type: none"> ● Wirings for the connector may be poorly installed. → Please confirm whether the wirings for the connector are properly installed and whether the wirings are connected.
Buttons are not working.	<ul style="list-style-type: none"> ● Wirings for the connector may be poorly installed. → Please confirm whether the wirings for the connector are properly installed and whether the wirings are connected. 		

If you can't resolve the problems according to the steps above, please contact your local distributors.