



● Thank you for purchasing **super slim style thermometer**, before operating the unit, please read the instruction thoroughly and retain it for the future reference.

⚠ Notice

1. The lcd meter is apply for **DC 12V**.
2. For installation, please follow the steps described in manual. Any damage caused by wrong installation shall be imputed to the users.
3. Don't break or modify the wire terminal. To avoid the short circuit, please don't pull the wire when installing.
4. Do not disassemble or change any parts excluding the manual description.
5. The interior examination or maintenance should be executed by our professionals.

MARK MEANING:

NOTE You could get the installation details from the information behind the mark.

⚠ Some processes must be followed to avoid the affection caused by wrong installation.

⚠ WARNING! Some processes must be followed to avoid damages to yourself or the public

⚠ CAUTION! Some processes must be followed to avoid the damage to the vehicle.

1 Accessory

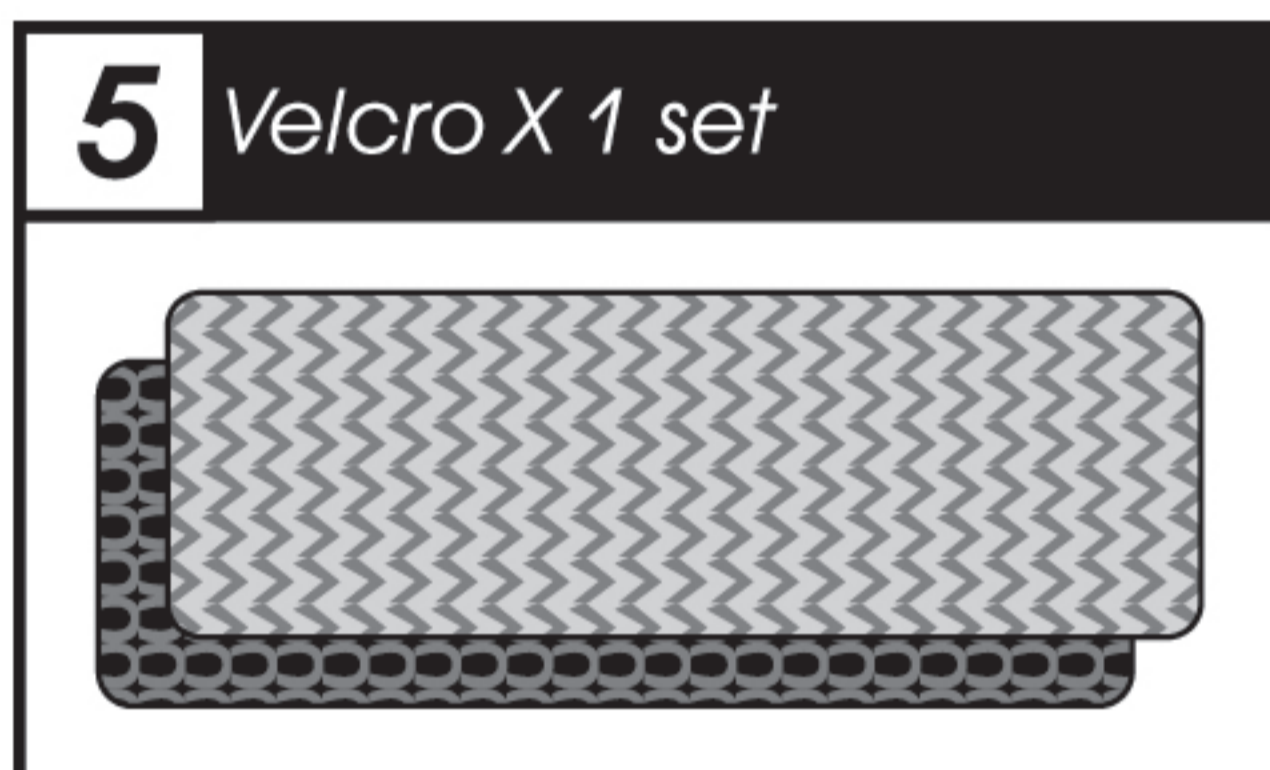
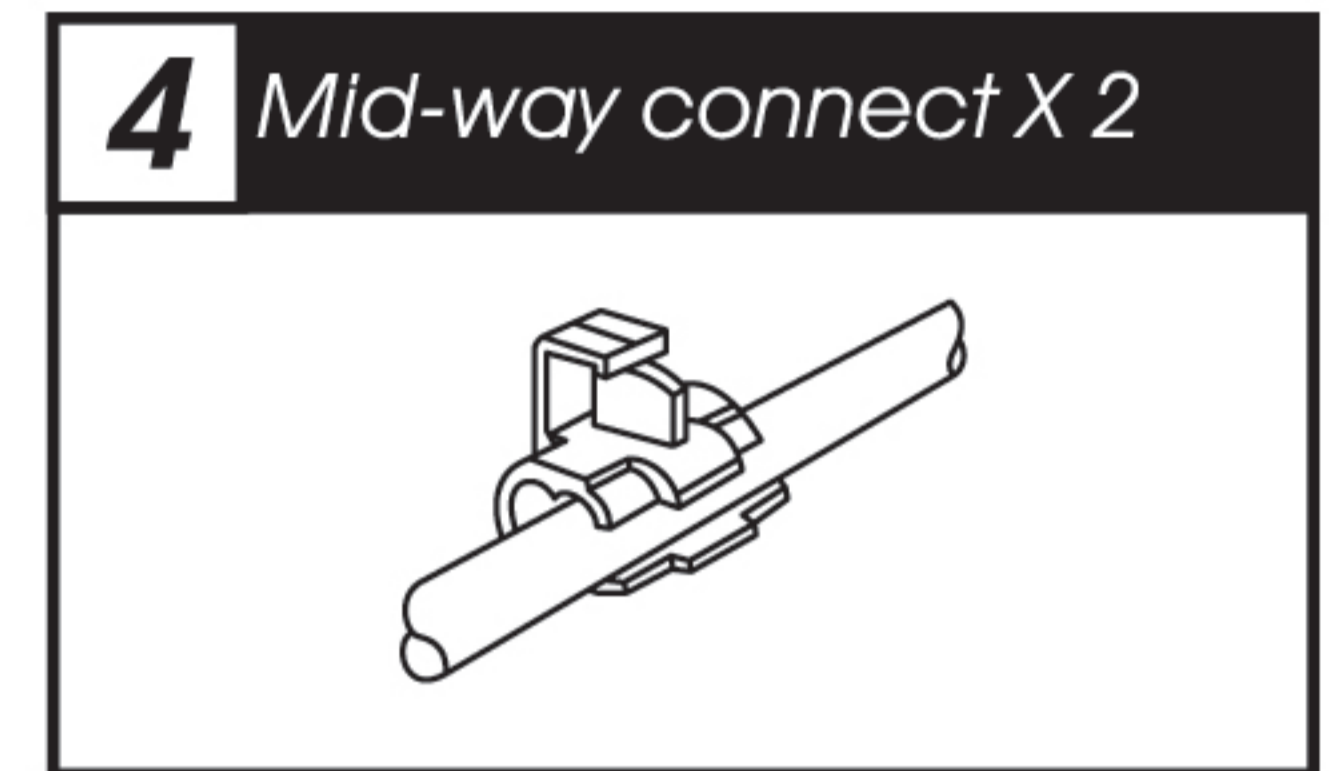
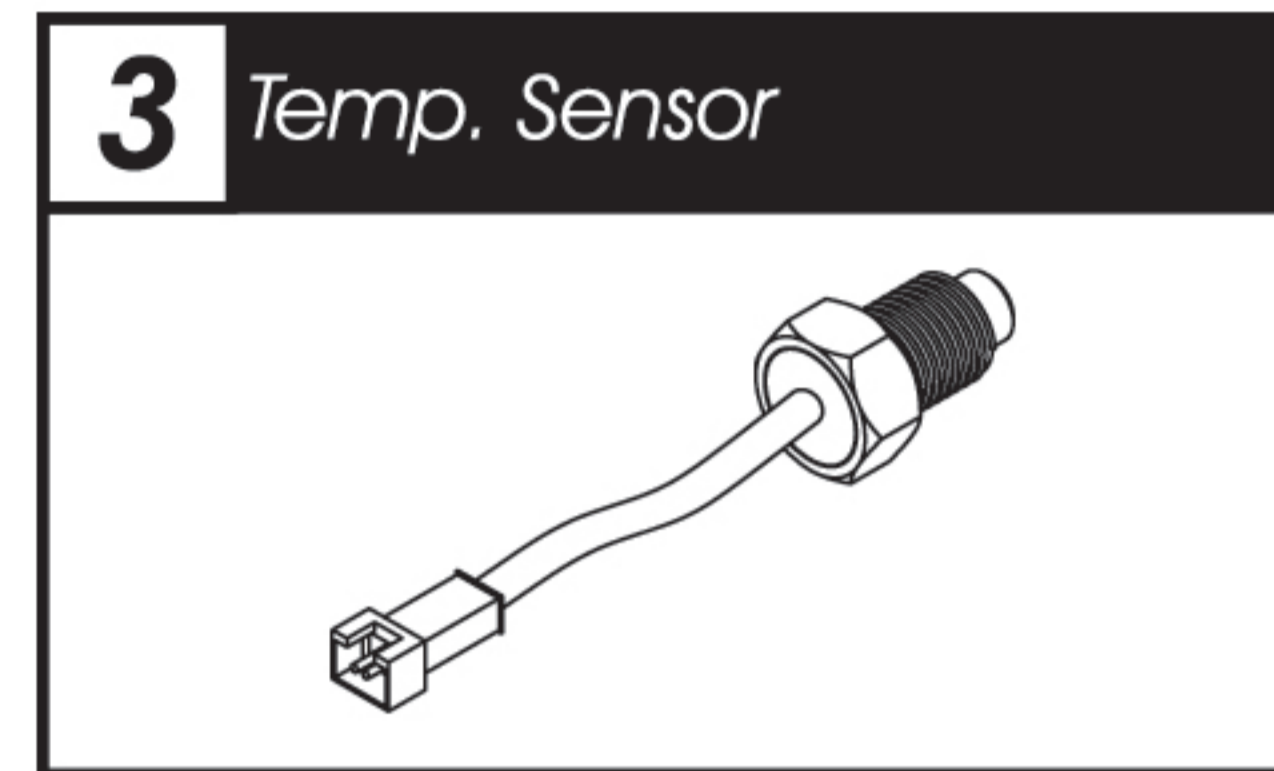
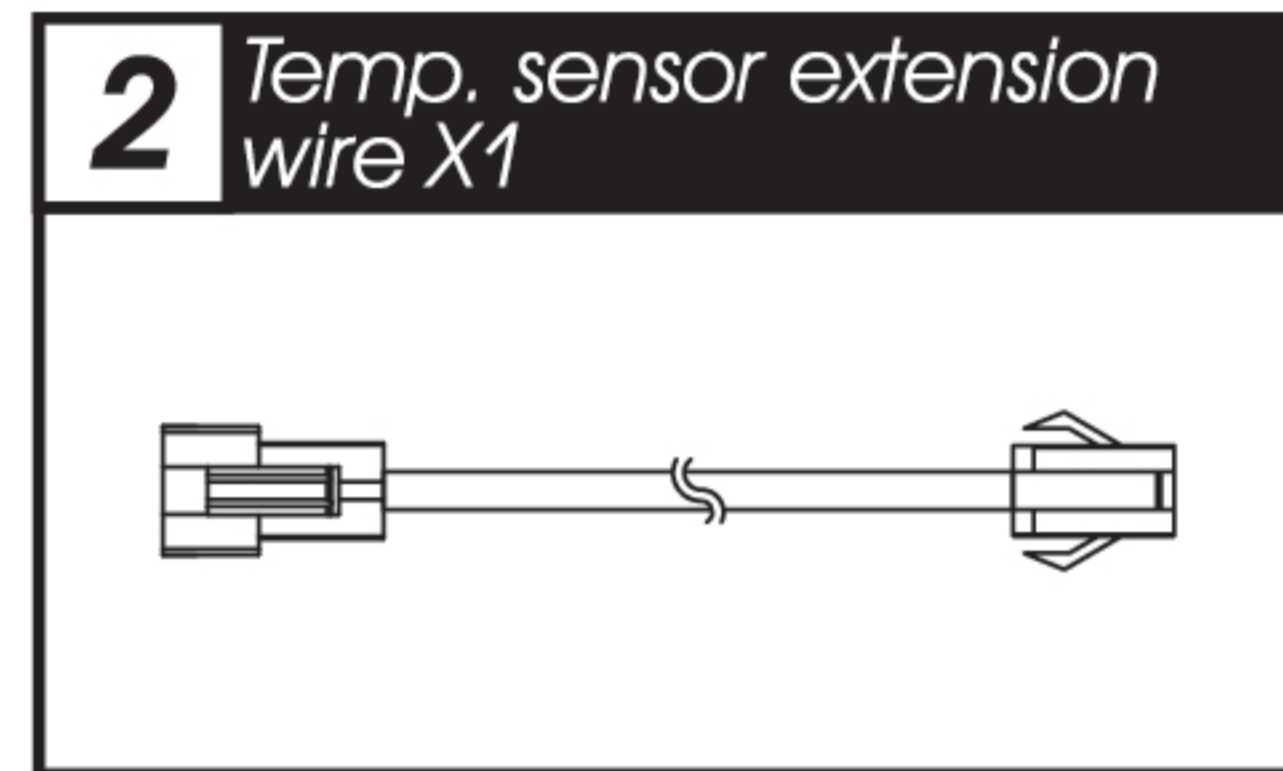
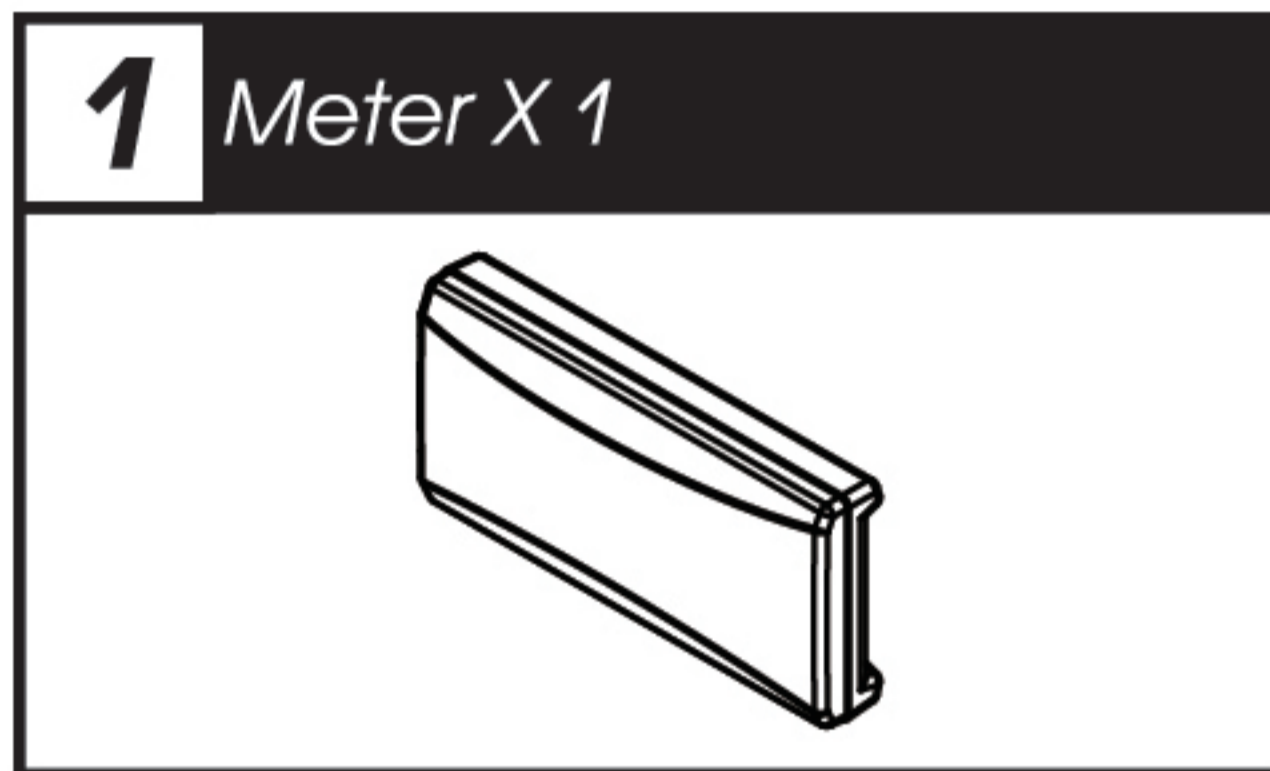

NOTE Please contact the local distributor if the items you open are not the same, with the above-listed one.

2 Wiring installation instructions

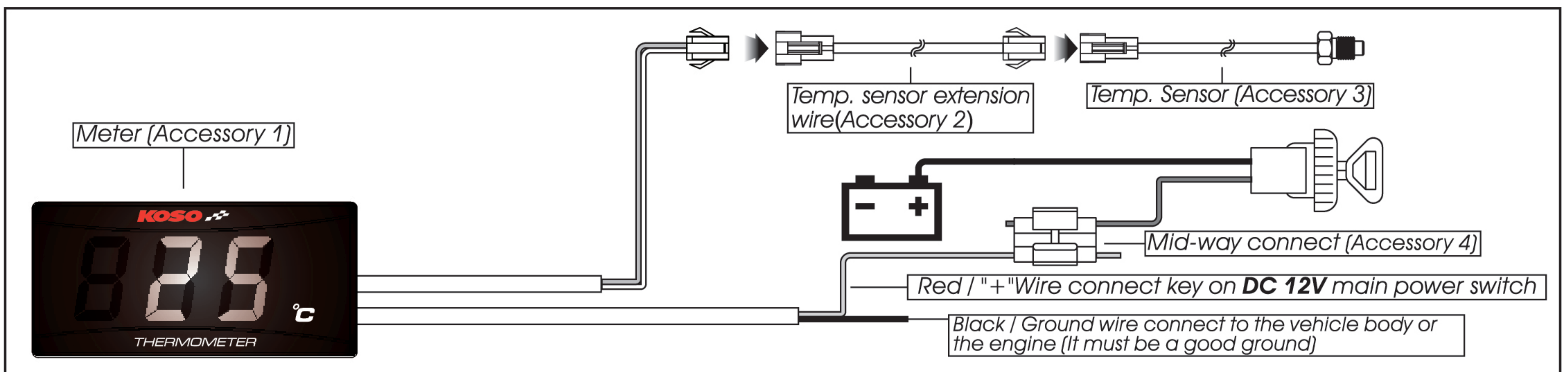

3 Instruction of function

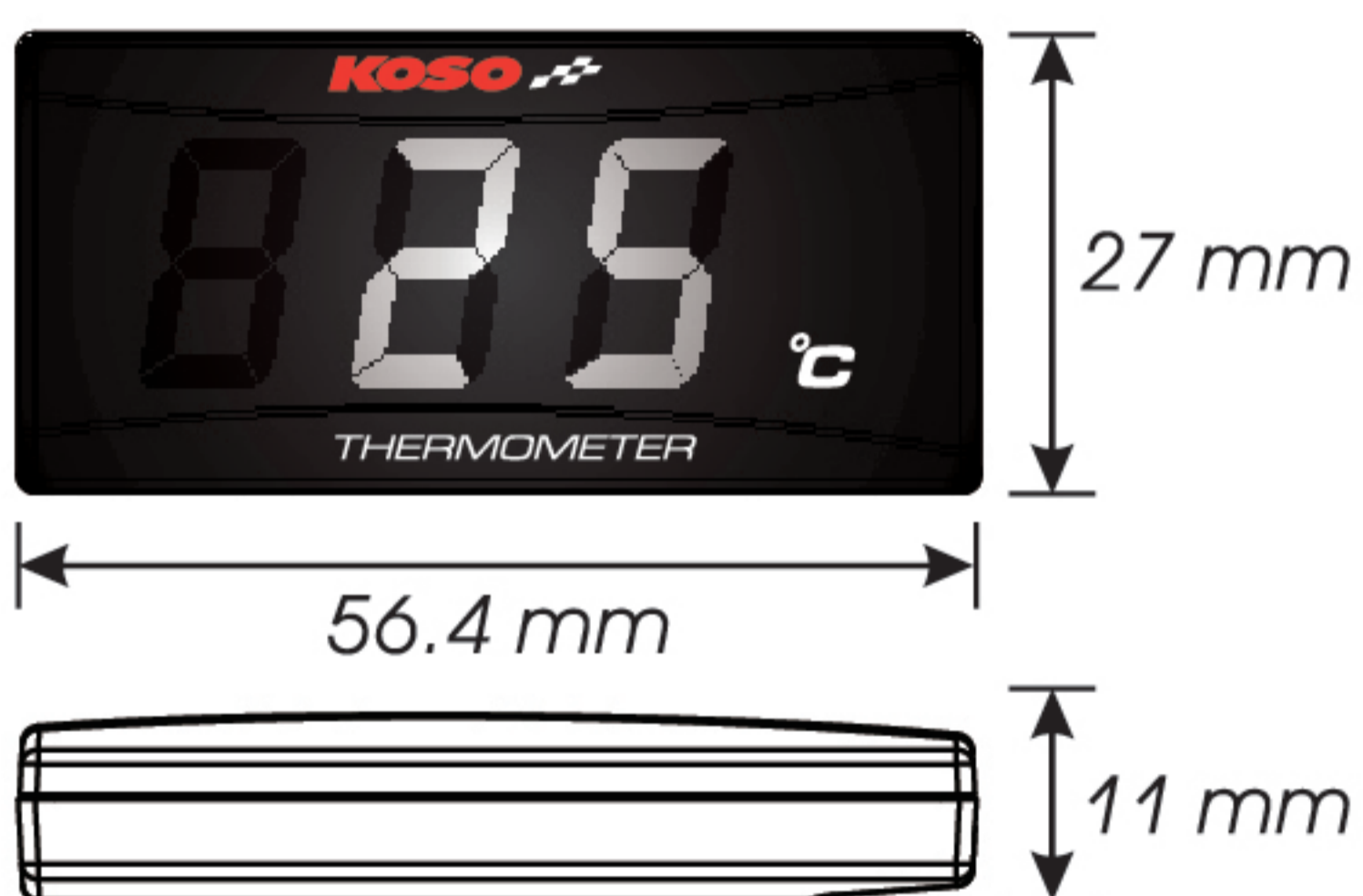

- Thermometer Display range : 0~120°C
Display unit : 1°C
- Temperature Warning When the temperature is over 120 °C., the meter will flash to warn you.
- Effective voltage **DC12V**
- Effective temperature range -10~+60°C
- Meter standard JIS D 0203 S2
- Meter size 56.4 X 27 X 11 mm
- Meter weight Around 22 g

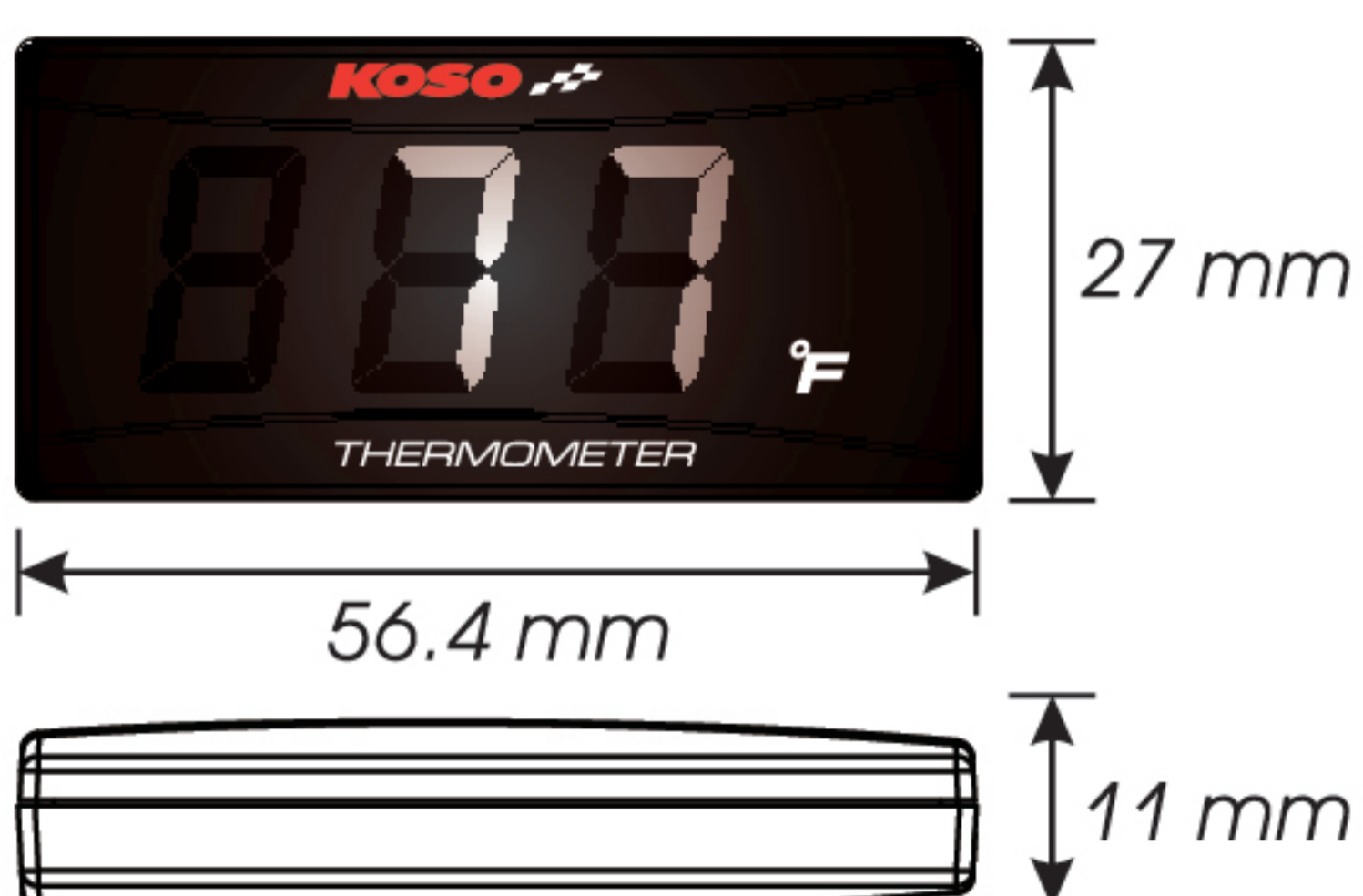

- Thermometer Display range : 32~248 °F
Display unit : 1°F
- Temperature Warning When the temperature is over 248°F., the meter will flash to warn you.
- Effective voltage **DC12V**
- Effective temperature range -10~+60°C
- Meter standard JIS D 0203 S2
- Meter size 56.4 X 27 X 11 mm
- Meter weight Around 22 g

NOTE Design and specifications are subject to change without notice!

4 Trouble shooting

The following situation do not indicate malfunction of the meter. Please check the following before taking it in for repair.

Trouble	Check item	Trouble	Check item
The meter doesn't work when the power is on.	●The power doesn't supply to the meter. →Please make sure the wiring is connected. The wiring and fuse are not broken. →The battery is broken or the battery is too old to supply enough power (DC 8V) to make the meter work.	No temperature showed	●Please check the sensor. →Does the wiring break or falling off ?
The meter shows wrong information.	●Please check the voltage of your battery, and make sure the voltage is over DC 8V.		

※If still can't solve the problems according to the steps above, please contact with distributors or us.