



INSTRUCTION



● Thank you for purchasing **Mini 3 thermometer**. Before operating the unit, please read the instruction thoroughly and retain it for the future reference.

Notice

1. The lcd meter is apply for **DC 12V**.
2. For installation, please follow the steps described in manual. Any damage caused by wrong installation shall be imputed to the users.
3. Don't break or modify the wire terminal. To avoid the short circuit, please don't pull the wire when installing.
4. Do not disassemble or change any parts excluding the manual description.
5. The interior examination or maintenance should be executed by our professionals.

MARK MEANING:

NOTE You could get the installation details from the information behind the mark.

▲ Some processes must be followed to avoid the affection caused by wrong installation.

▲ **WARNING!** Some processes must be followed to avoid damages to yourself or the public.

▲ **CAUTION!** Some processes must be followed to avoid the damage to the vehicle.



PRESS THE BUTTON ONE TIME



PRESS THE BUTTON 3 SECONDS

1-1 Accessory

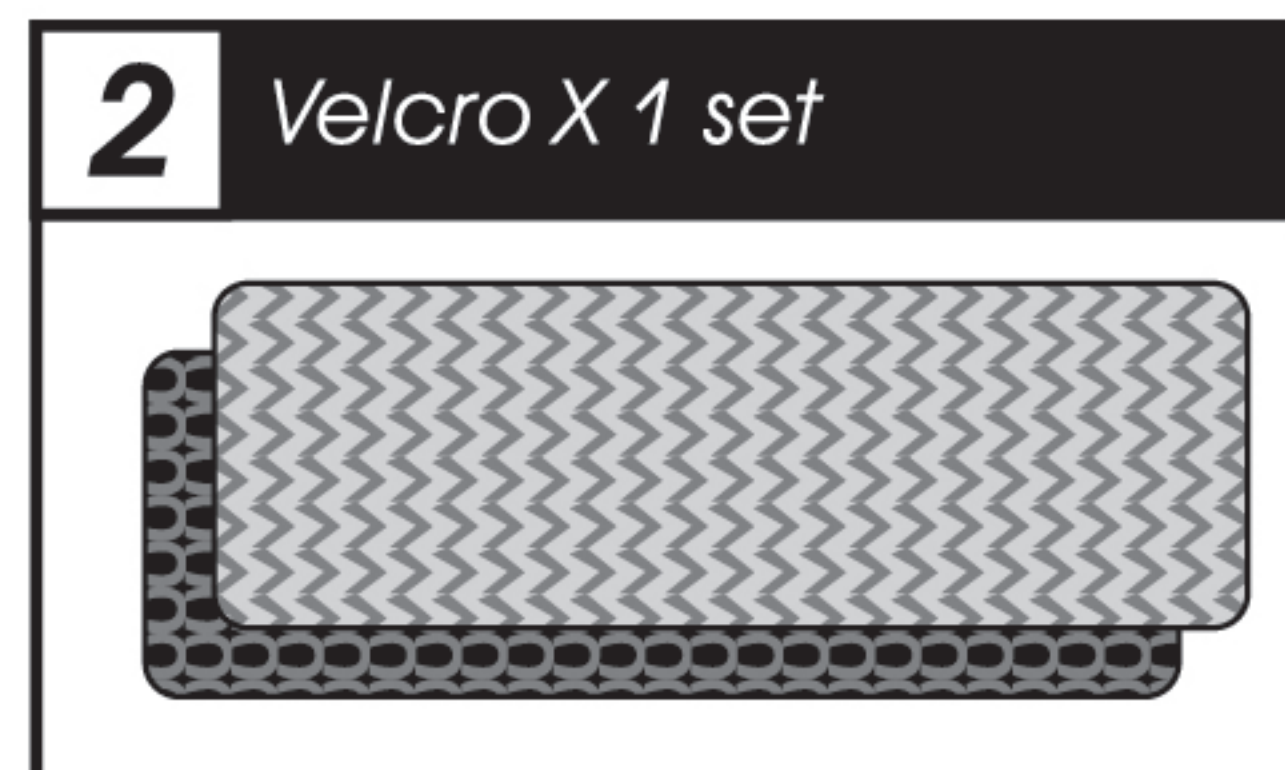
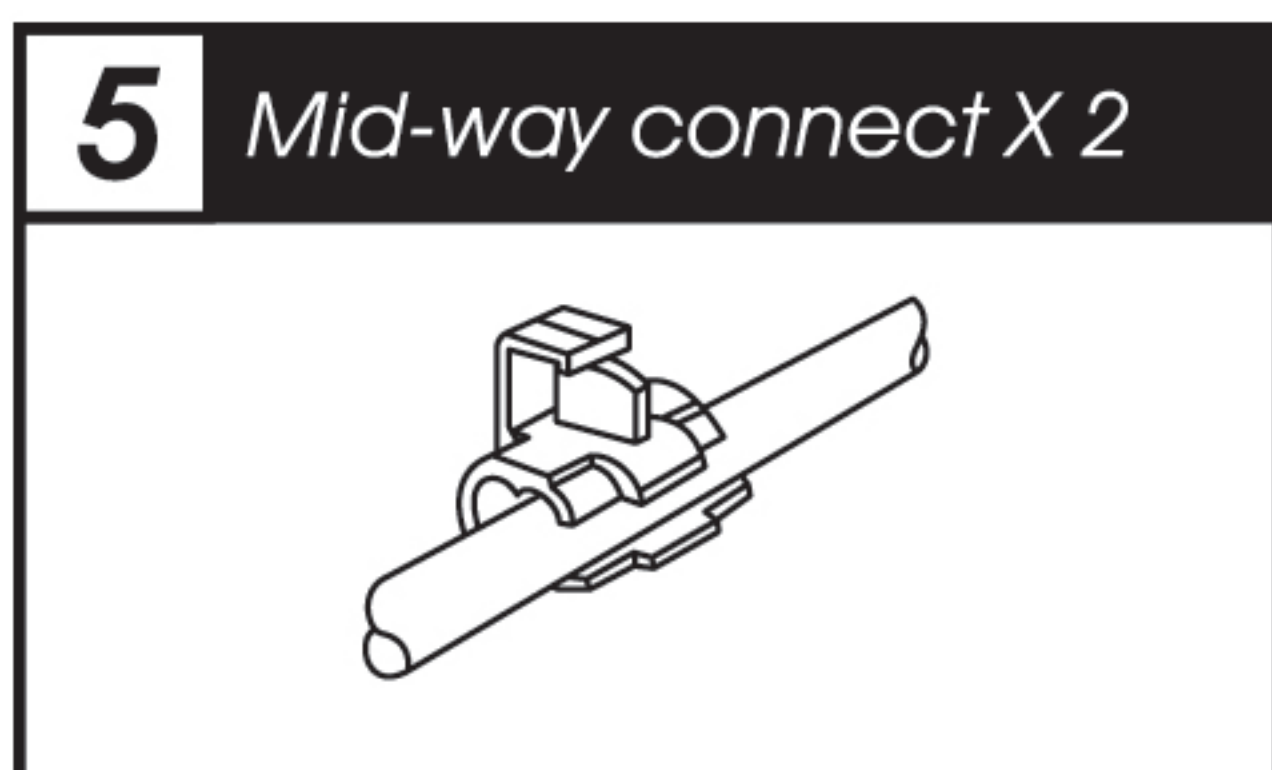
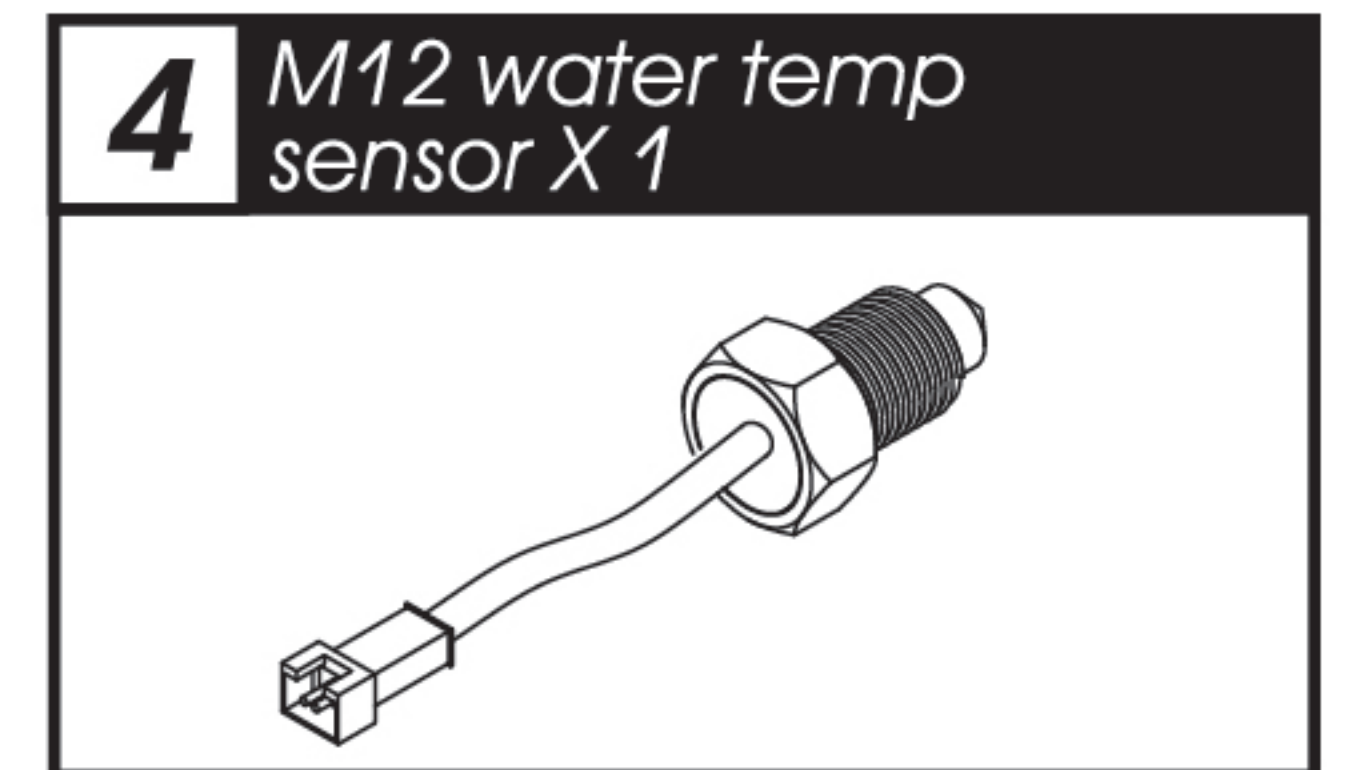
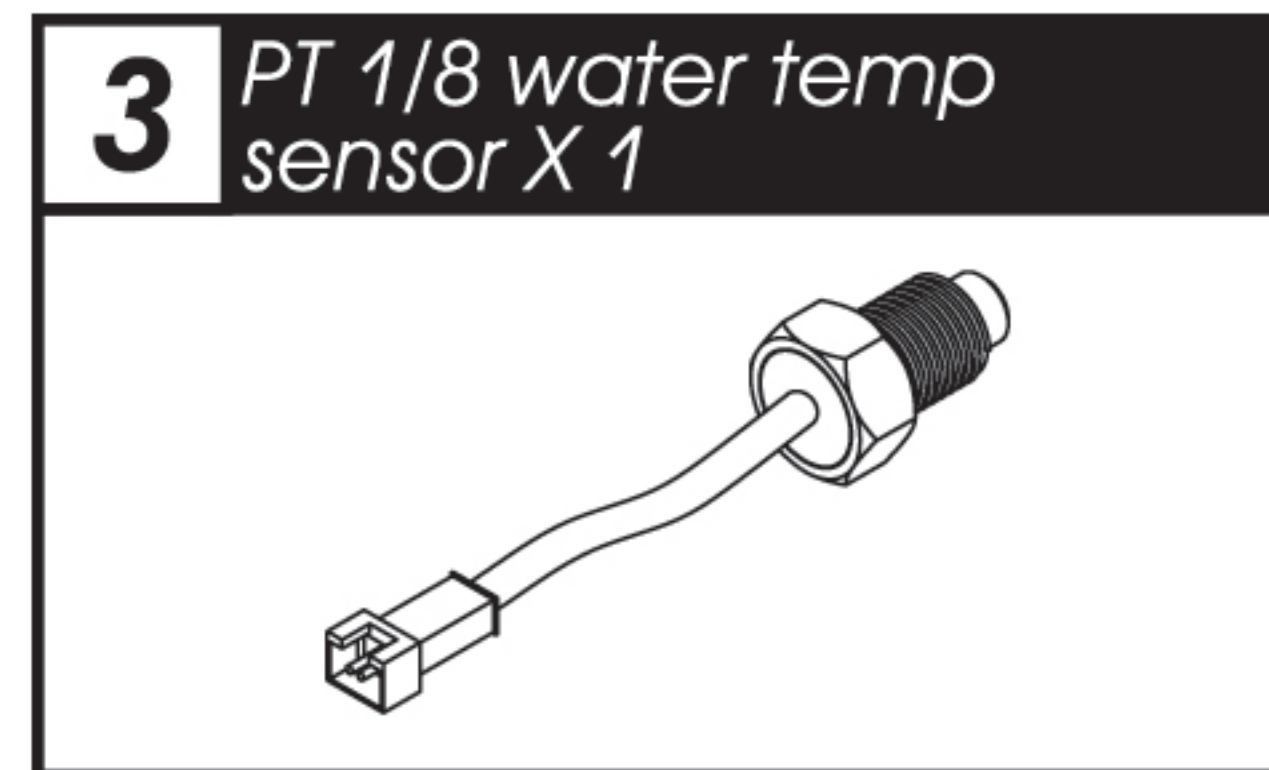
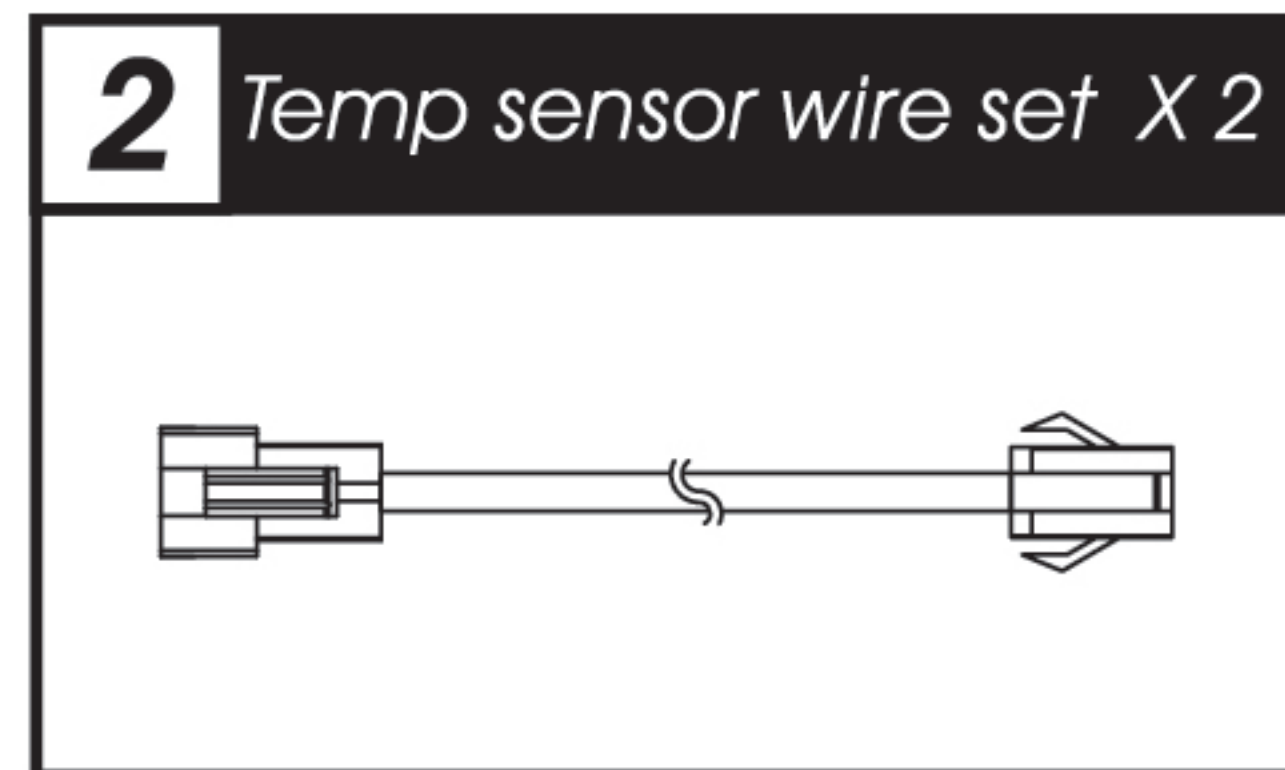
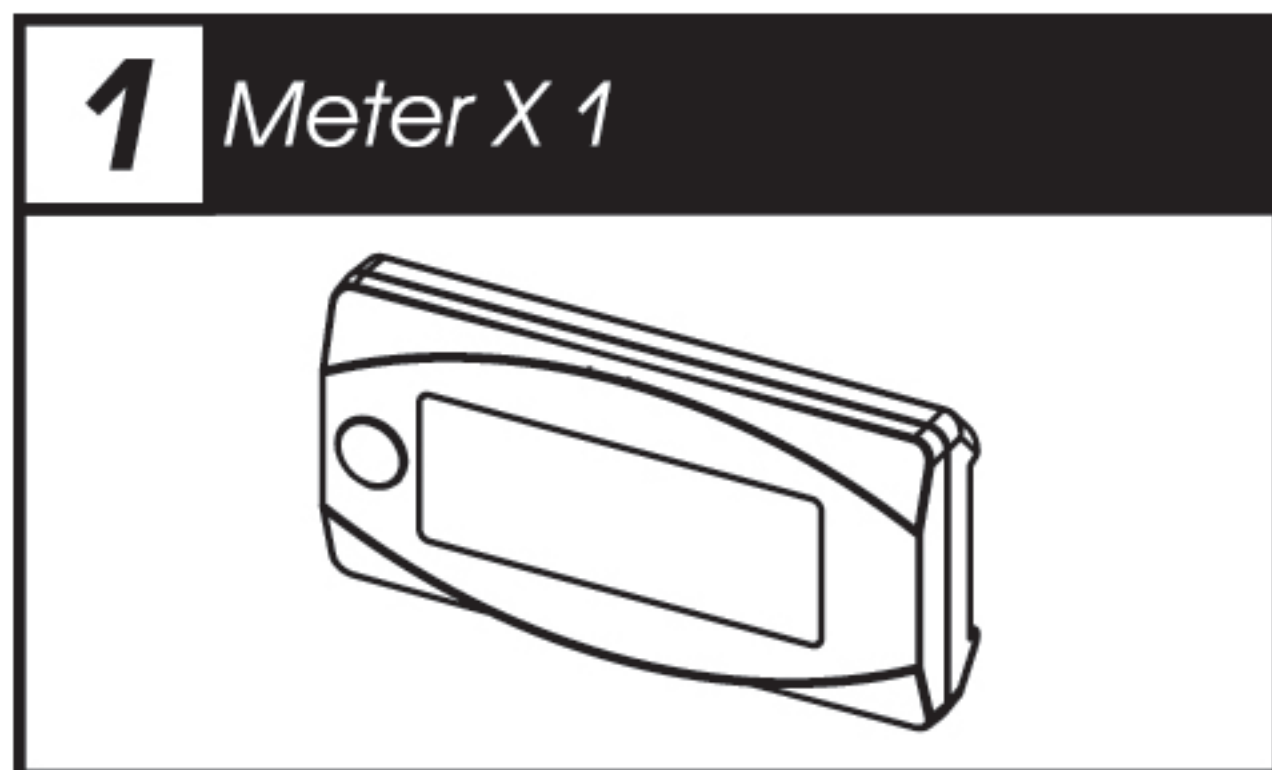

NOTE Please contact the local distributor if the items you open are not the same, with the above-listed one.

1-2 Option accessory

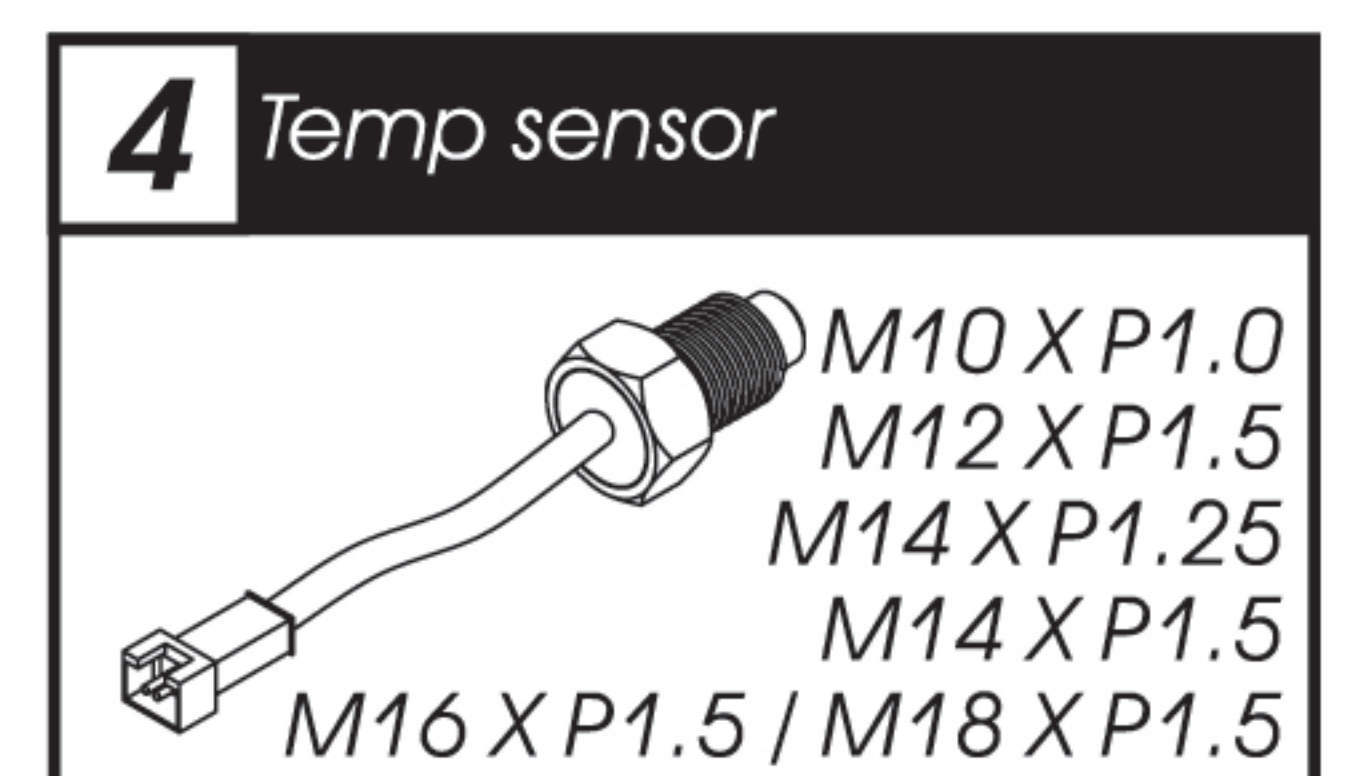
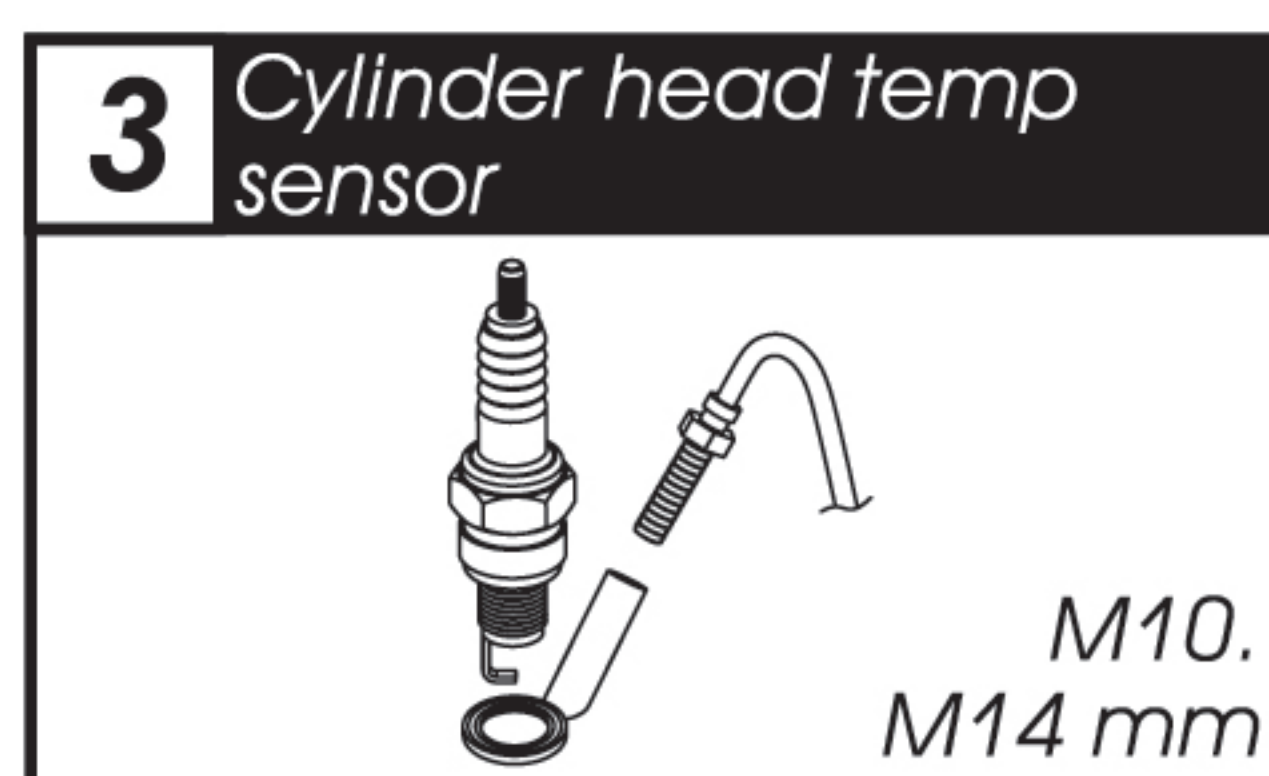
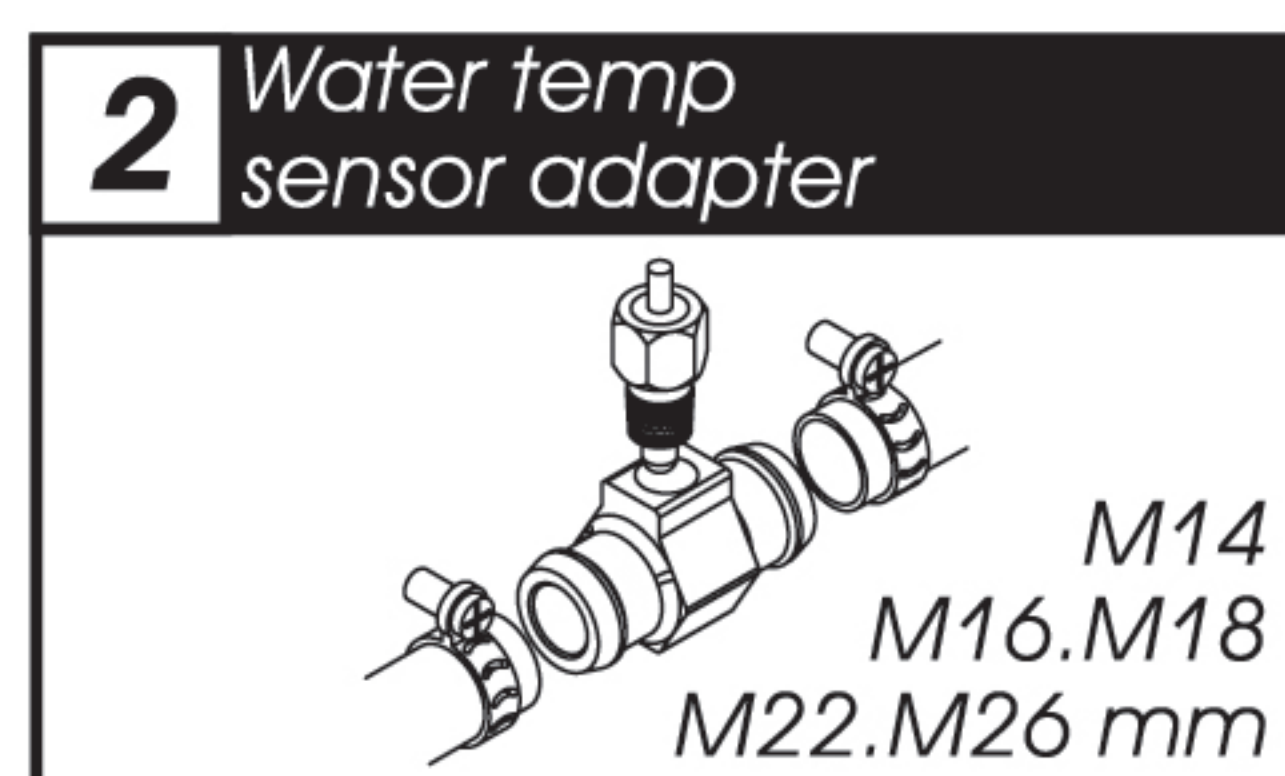
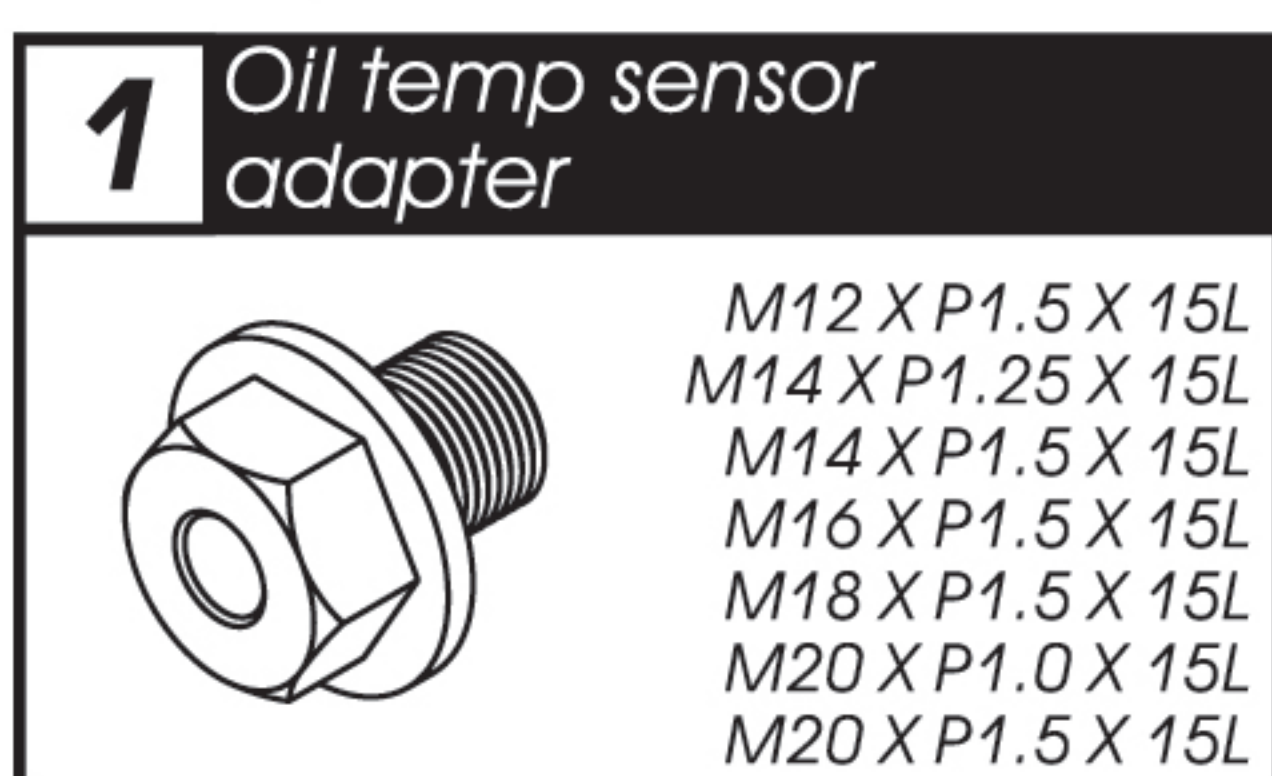

NOTE Some of the option accessories may not sell. For the details, please contact the local distributor.

2 Wiring installation instructions

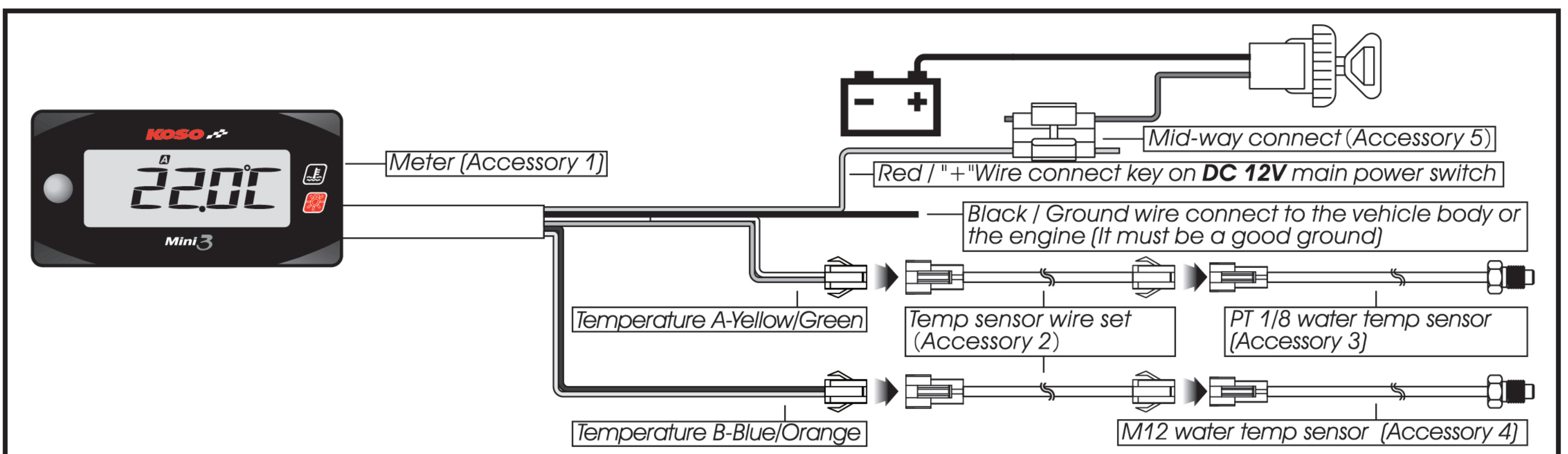

3 Function instruction

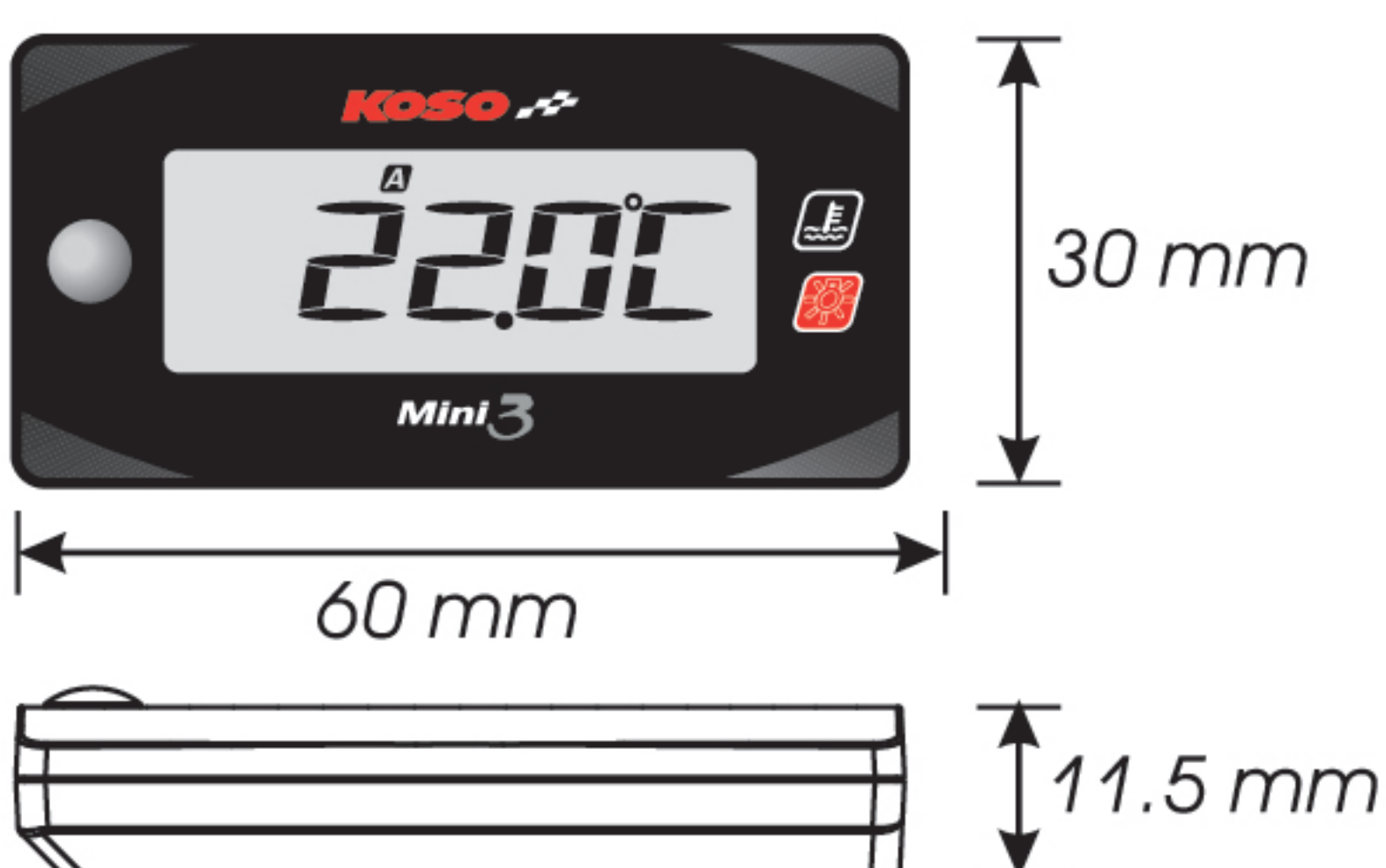

● Thermometer A,B	Display range : 0~120°C (32~248 °F) Display unit : 0.1°C (°F)
○ Temperature Warning	When the temperature is over 120 °C (248°F) the meter will flash to warn you.
● Effective voltage	DC12V
● Effective temperature range	-10~+60°C
● Meter standard	JIS D 0203 S2
● Meter size	60 X 30 X 11.5 mm
● Meter weight	Around 22 g

NOTE Design and specifications are subject to change without notice!

4-1 Centigrade / Fahrenheit adjustment



- The default temperature unit setting is Centigrade. Please hold pressing the button for 3 seconds to switch the temperature unit to Fahrenheit.

NOTE Temperature display unit can be set on °C or °F

WARNING! Please don't check the record during riding to avoid the accident.



- Now the temperature unit is changed to Fahrenheit. To switch the temperature unit back to the Centigrade, please hold pressing the button for 3 seconds again.



- Now the temperature is returned to the Centigrade!

4-2 Temperature A/B screen setting instructions



- In temp A screen, press the button once to switch from temp A to temp B



- In temp B screen, press the button once to switch from temp B to temp A.



- The temp A screen.

5 Trouble shooting

The following situation do not indicate malfunction of the meter. Please check the following before taking it in for repair.

Trouble	Check item	Trouble	Check item
The meter doesn't work when the power is on.	<ul style="list-style-type: none"> ● The power doesn't supply to the meter. → Please make sure the wiring is connected. The wiring and fuse are not broken. 	Temp does not appear or appear incorrectly.	<ul style="list-style-type: none"> ● Please check the sensor. → Does the wiring break or falling off?

※If still can't solve the problems according to the steps above, please contact with distributors or us.